

OSCAR, OSCAR D, OSCAR W, OSCAR V, DAVIDA

Installation Manual

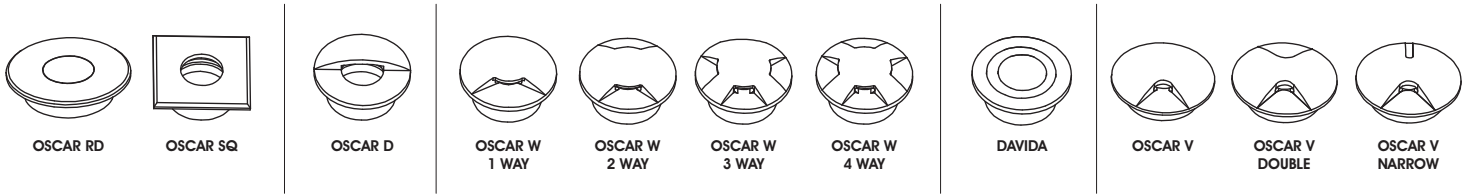

Installation WITH Mounting Box ACR.159

1



Attention

Before any maintenance switch off the main power.

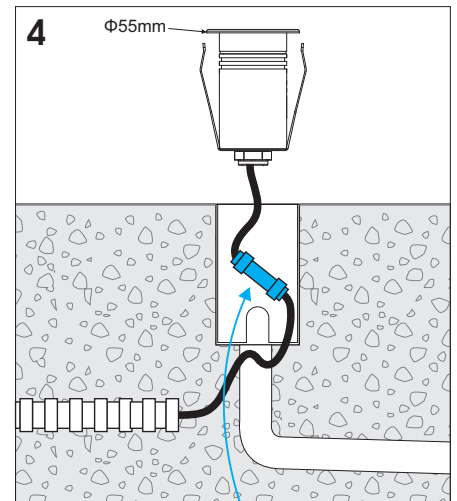
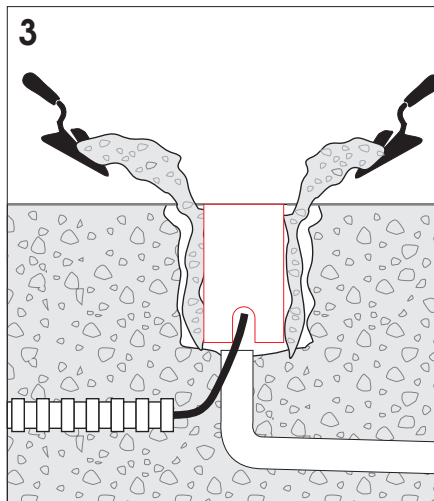
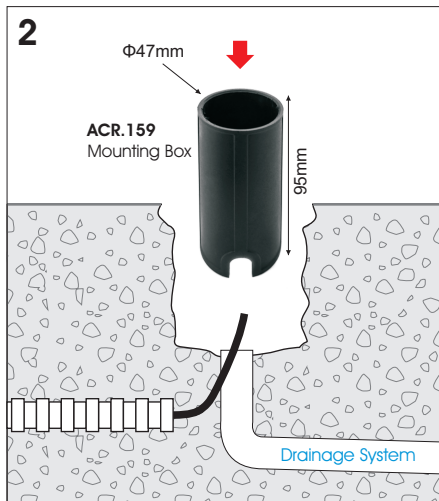
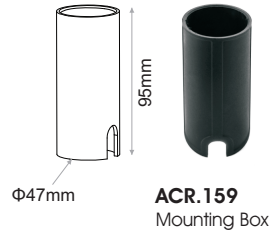
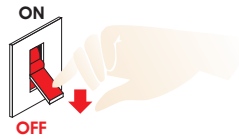

For cable connection you must use IP68 connectors or junction box.

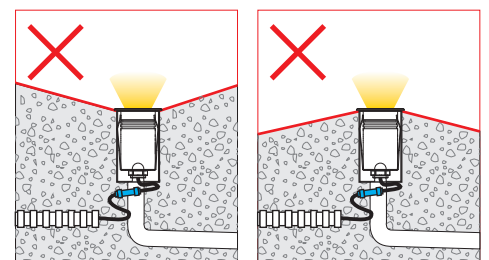
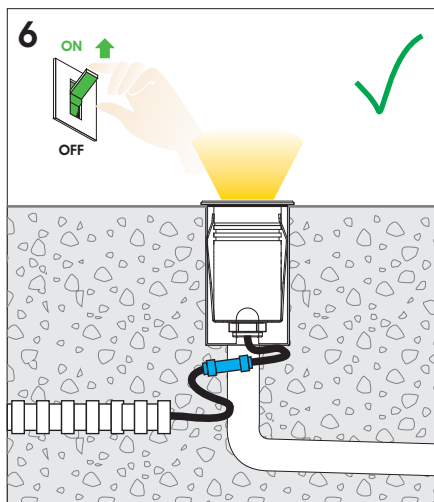
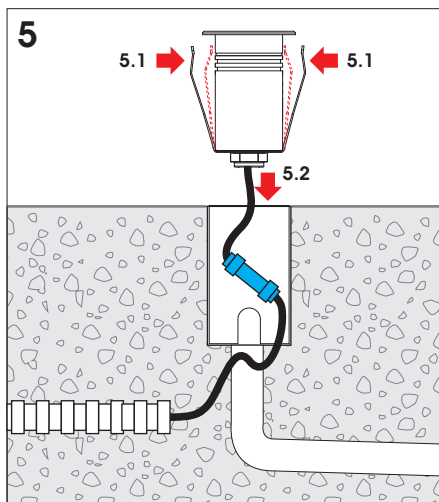

Installation WITH Mounting Boxes ACR.175 / ACR.157

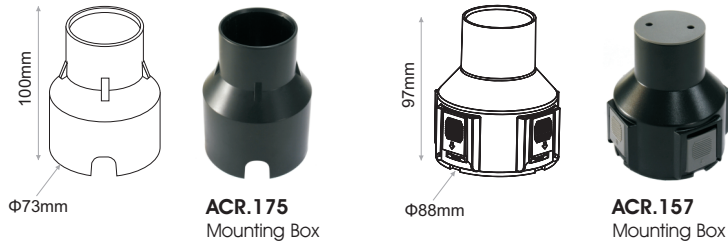

1
Attention
Before any maintenance switch off the main power.

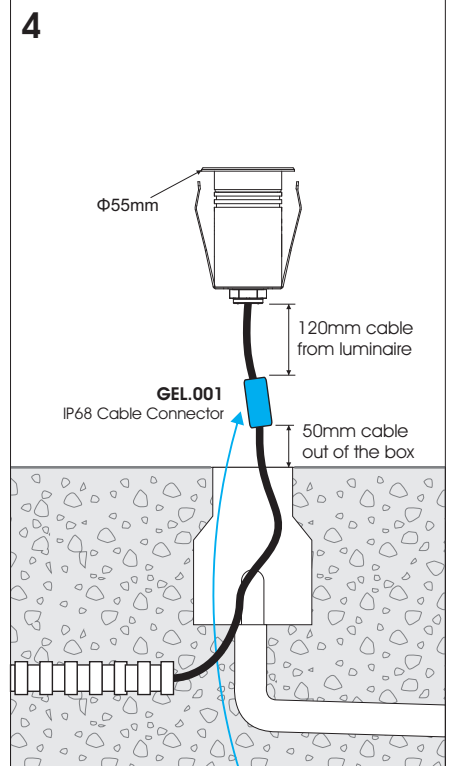
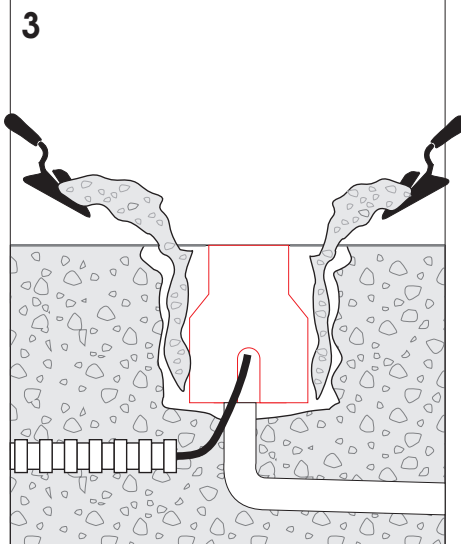
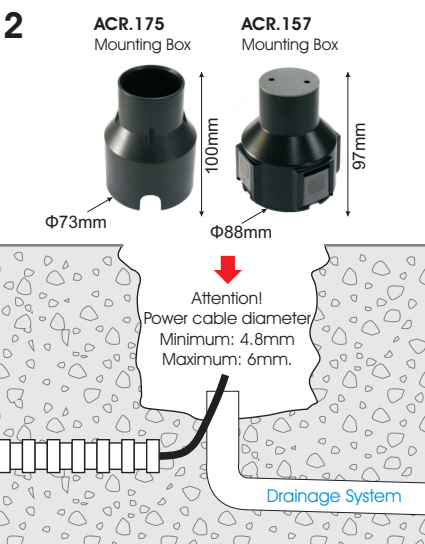
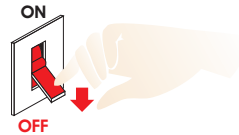

GEL.001
IP68 Cable Connector as extra
For cable connection you must use IP68 connects or junction box.

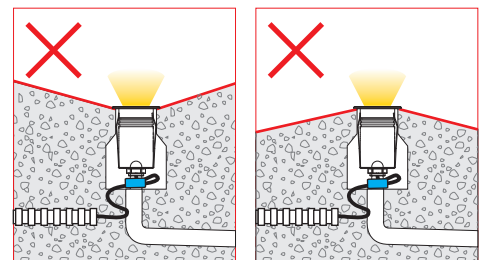
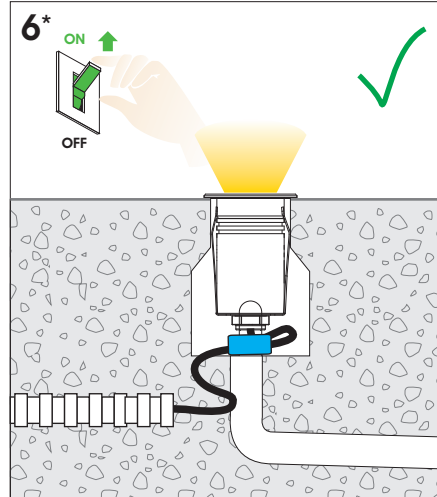
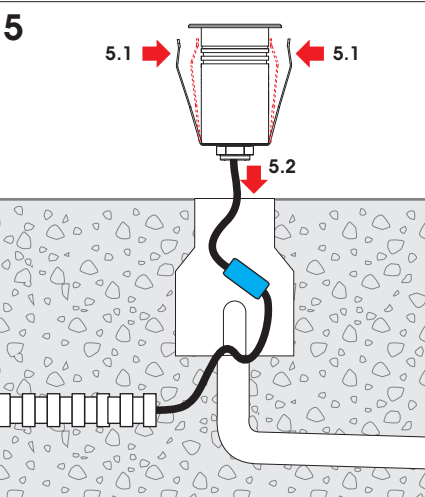

* If an IP68 cable connector with larger dimensions than GEL.001 is used, then the IP68 cable connector will be outside the mounting box. Please refer to page 1 image 6.

Installation WITHOUT Mounting Box

1

Attention
Before any maintenance switch off the main power.

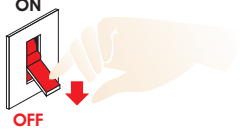
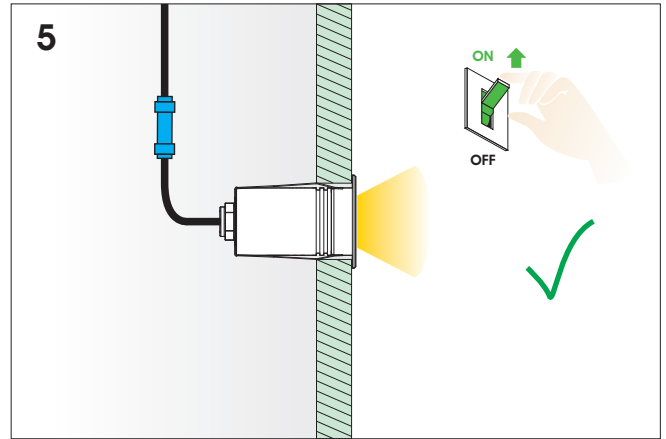
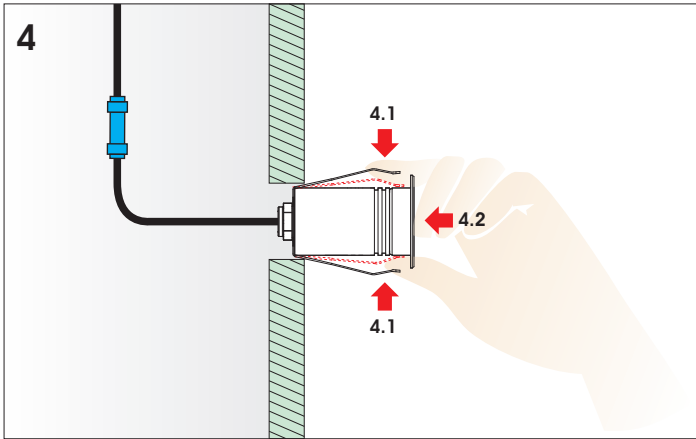
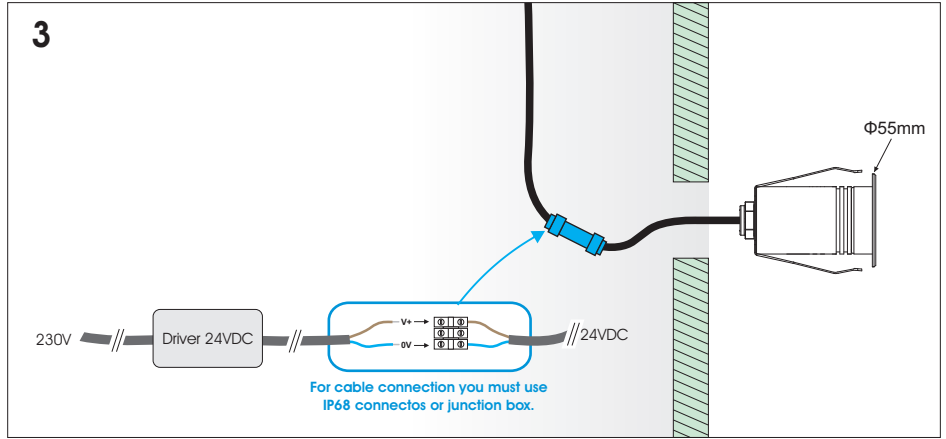
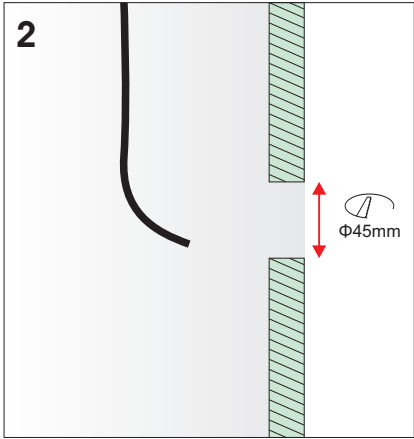
Connection Diagram

- > This LED luminaire must be connected to a constant voltage converter 24VDC. **WARNING!** Incorrect connection may damage the luminaire.
- > Connect the LED luminaire to the converter before the converter is connected to the power source.

